

**This schematic has several known mistakes!
Do not use as a reliable source of information!**

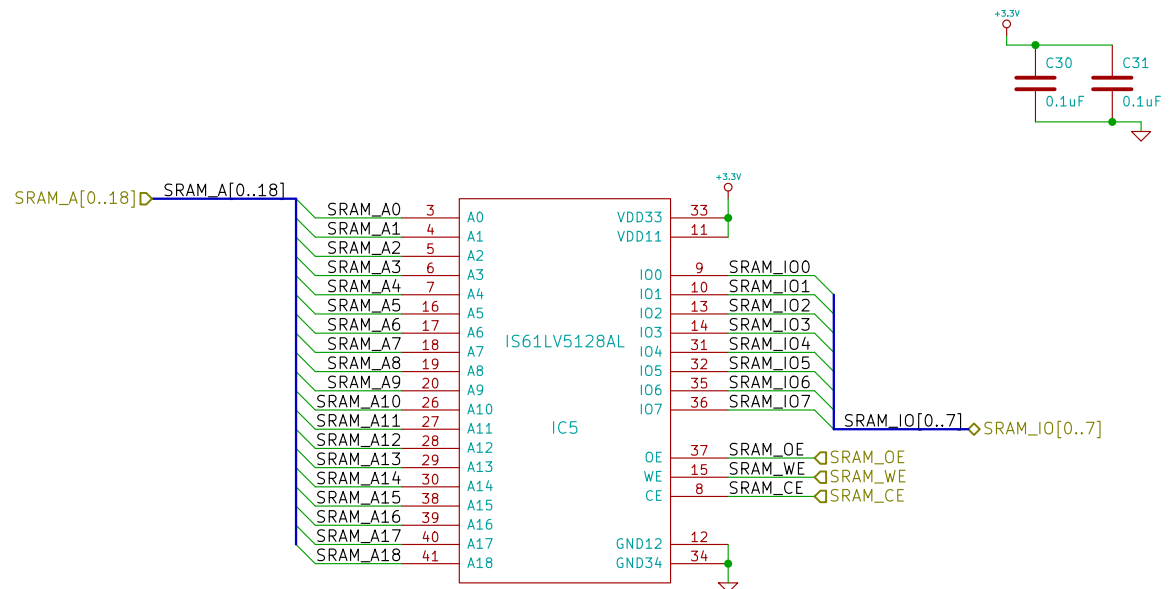

File: grabor_sram.sch	
Sheet: /sram/	
Title:	
Size: A4	Date: 19 apr 2013
KiCad E.D.A.	Rev: Id: 2/5

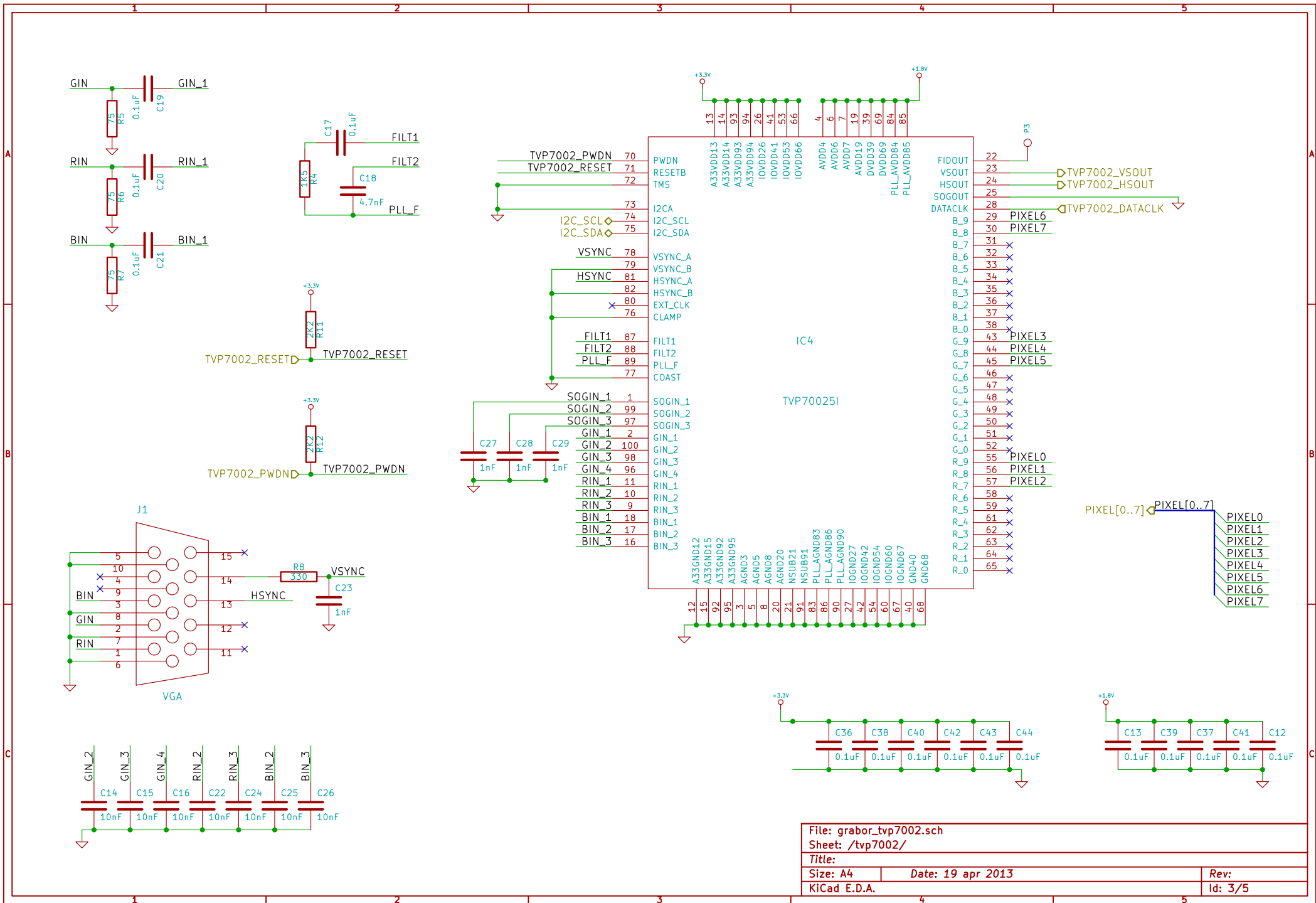

File: grabor_tvp7002.sch		
Sheet: /tvp7002/		
Title:		
Size: A4	Date: 19 apr 2013	Rev:
KiCad E.D.A.		Id: 3/5

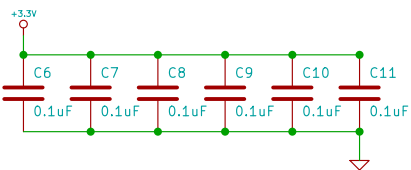
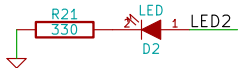
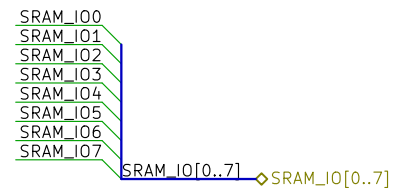
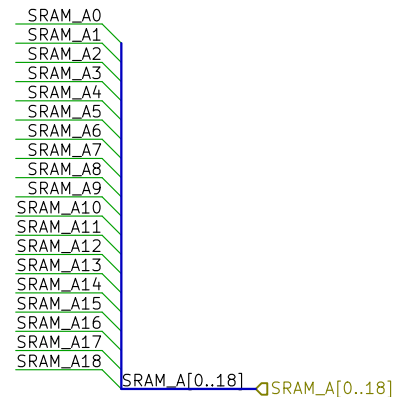
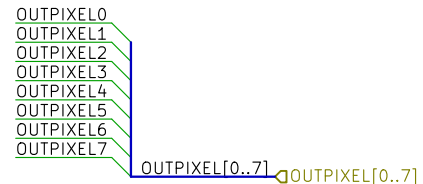
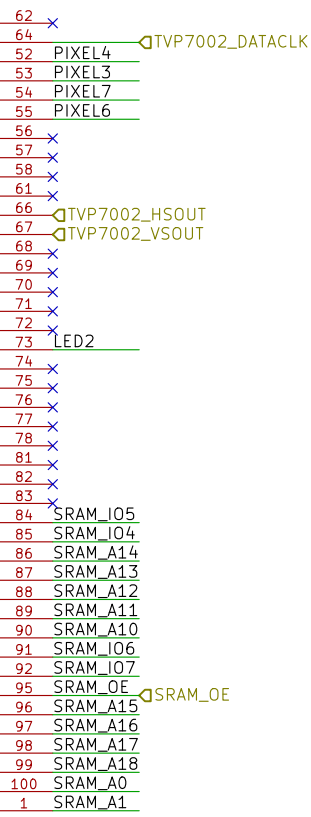
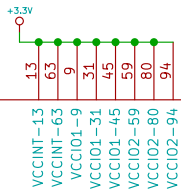
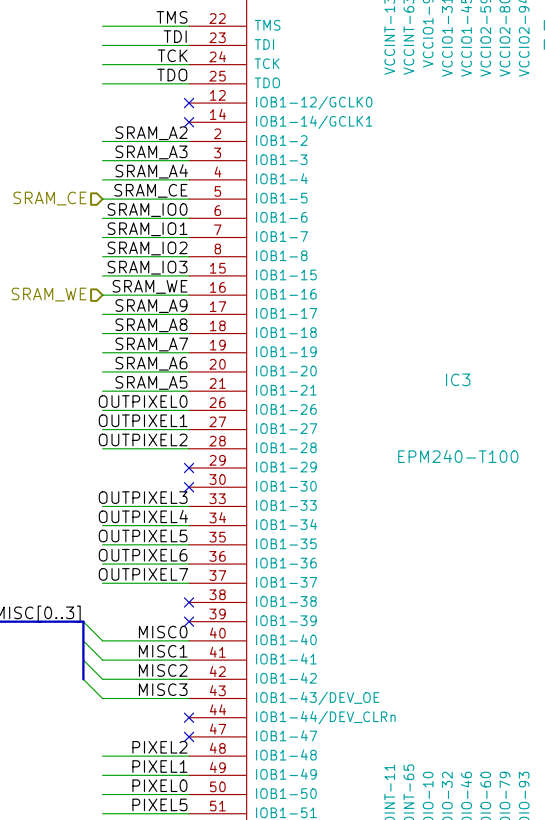
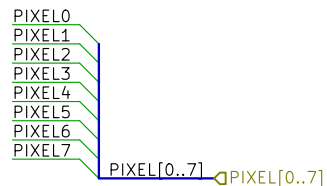
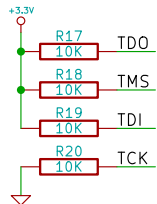
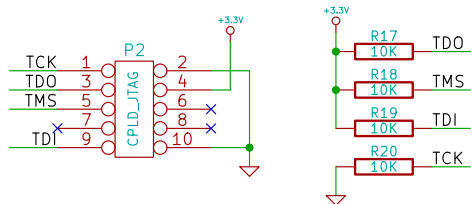

File: grabor_cp1d.sch		
Sheet: /cp1d/		
Title:		
Size: A4	Date: 19 apr 2013	Rev:
KiCad E.D.A.		Id: 4/5

